

Introducing the *PGSB* Snap Bushing

Features and Benefits

- Converts raw or sharp edged holes into smooth, insulated holes
- Insulates and protects cables
- Easily snapped into hole by hand
- Available in 42 new sizes to accommodate various hole diameters, panel thicknesses and inside diameters

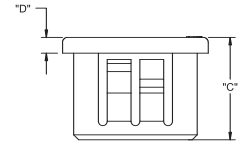
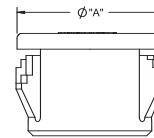
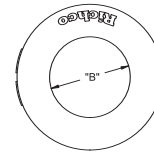
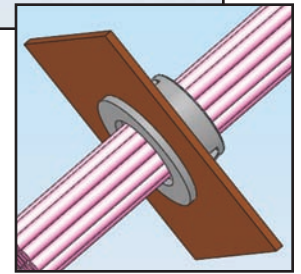
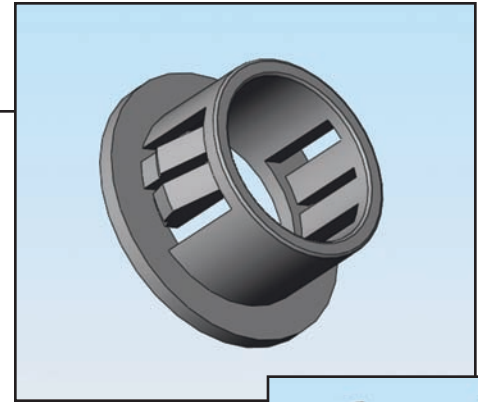

Material: UL94 V2 Nylon 6/6, RMS-01* Color: Black								
Part No.	Hole Diameter	Panel Thickness	"A" ±.020	"B" Ref	"C" ±.010	"D"	Standard Pkg.	
PGSB-0305	.189±.003 (4.8)	.063-.067 (1.6-1.7)	.26 (6.5)	.125 (3.2)	.24 (6)	.051 (1.36)	1000	
PGSB-1	.250±.003 (6.35)	.062 (1.57) Max	.312 (7.9)	.187 (4.7)	.312 (7.9)	.063 (1.6)		
PGSB-2	.312±.003 (7.9)		.375 (9.5)	.250 (6.35)	.237 (6)	.050 (1.27)		
PGSB-4	.375±.002 (9.5)	.031-.125 (0.8-3.2)	.468 (11.9)	.187 (4.7)	.406 (10.3)	.055 (1.4)		
PGSB-5	.375±.002 (9.5)	.031-.125 (0.8-3.2)	.468 (11.9)	.250 (6.35)	.406 (10.3)	.051 (1.3)		
PGSB-0710	.394±.003 (10)	.031-.071 (0.8-1.8)	.472 (12)	.284 (7.2)	.260 (6.6)	.051 (1.3)	500	
PGSB-6	.437±.002 (11)	.031-.125 (0.8-3.2)	.531 (13.5)	.270 (6.85)	.406 (10.3)	.055 (1.4)		
PGSB-7				.312 (7.9)				
PGSB-8				.243 (6.2)				
PGSB-9	.468±.002 (11.9)	.062 (1.57) Max		.363 (9.2)	.250 (6.35)	.050 (1.27)		
PGSB-10	.500±.002 (12.7)	.031-.125 (0.8-3.2)	.578 (14.7)	.250 (6.35)	.406 (10.3)	.063 (1.6)		
PGSB-11				.312 (7.9)				
PGSB-12				.375 (9.5)				
PGSB-1013	.512±.003 (13)	.031-.118 (0.8-3)	.591 (15)	.402 (10.2)	.354 (9)	.051 (1.3)		
PGSB-13	.531±.002 (13.5)	.062 (1.57) Max	.593 (15.1)	.406 (10.3)	.250 (6.35)	200		
PGSB-14	.562±.002 (14.3)	.031-.125 (0.8-3.2)	.656 (16.7)	.312 (7.9)	.406 (10.3)			.063 (1.6)
PGSB-15				.391 (9.9)				
PGSB-16				.437 (11.1)				
PGSB-17				.250 (6.35)				
PGSB-18	.625±.002 (15.9)		.718 (18.2)	.437 (11.1)	.250 (6.35)			
PGSB-19	.062 (1.57) Max	.703 (17.85)	.500 (12.7)	.250 (6.35)				
PGSB-1316	.630±.003 (16)	.055-.139 (1.4-3.5)	.709 (18)	.504 (12.8)		.409 (10.4)	.059 (1.5)	
PGSB-20	.687±.002 (17.5)	.031-.125 (0.8-3.2)	.781 (19.8)	.500 (12.7)	.406 (10.3)	.063 (1.6)	100	
PGSB-21	.687±.002 (17.5)	.031-.125 (0.8-3.2)	.781 (19.8)	.562 (14.3)	.406 (10.3)	.059 (1.5)		
PGSB-1519	.748±.003 (19)	.039-.130 (1.3-3)	.854 (21.7)	.602 (15.3)	.433 (11)	.059 (1.5)		
PGSB-22	.750±.002 (19.1)	.031-.125 (0.8-3.2)	.843 (21.4)	.500 (12.7)	.406 (10.3)	.063 (1.6)		
PGSB-23				.562 (13.5)				
PGSB-24				.828 (21)				
PGSB-25	.781±.002 (19.8)	.062 (1.57) Max	.859 (21.8)	.625 (15.9)	.250 (6.35)	200		
PGSB-1822	.866±.003 (22)	.035-.091 (0.9-2.3)	.976 (24.8)	.717 (18.2)	.059 (1.5)			
PGSB-26	.875±.002 (22.2)	.031-.125 (0.8-3.2)	.953 (24.2)	.500 (12.7)				.453 (11.5)
PGSB-27				.562 (14.3)				
PGSB-28				.625 (15.9)				
PGSB-29				.687 (17.5)				
PGSB-30	.062 (1.57) Max	.937 (23.8)	.750 (19.1)	.250 (6.35)	.063 (1.6)			
PGSB-31	1.00±.002 (25.4)	.031-.125 (0.8-3.2)	1.125 (28.6)	.766 (19.45)	.453 (11.5)	100		
PGSB-32	1.097±.004 (27.86)		.812 (20.6)					
PGSB-33			1.218 (31)	.875 (22.2)				
PGSB-34			.937 (23.8)					
PGSB-2428	1.102±.003 (28)	.039-.130 (1-3.3)	1.240 (31.5)	.945 (24)	.441 (11.2)	.059 (1.5)		
PGSB-2530	1.181±.003 (30)	.039-.122 (1-3.1)	1.319 (33.5)	.984 (25)	.071 (1.8)	200		
PGSB-35	1.25±.002 (31.75)	.031-.125 (0.8-3.2)	1.312 (33.3)	.937 (23.8)			.063 (1.6)	
PGSB-2634	1.347±.003 (34.2)	.039-.126 (1-3.2)	1.496 (38)	1.031 (26.2)	.059 (1.5)	100		
PGSB-36	1.375±.002 (34.9)	.031-.125 (0.8-3.2)	1.468 (41.9)	1.00 (25.4)				
PGSB-37	1.50±.002 (38.1)		1.062 (27)	.453 (11.5)	.063 (1.6)			
PGSB-38			1.125 (28.6)					
PGSB-39			1.312 (33.3)					
PGSB-40	1.75±.002 (44.45)		1.875 (47.6)	1.375 (34.9)	1.64 (41.7)			
PGSB-41	2.00±.002 (50.8)		2.125 (54)	1.75 (44.5)				
PGSB-42								

*Available in UL94 V0 material by special order. To order, add -V0 to the end of the part number

Parts available in White by special order. To order, add WH to the end of the part number

Markets

- Electrical
- Telecommunications
- White Goods
- Consumer Electronics
- Point of Purchase

Other Related Richco Product Solutions

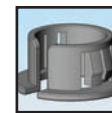

PGSB-A

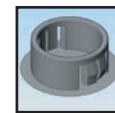

PGM



HG



QFG

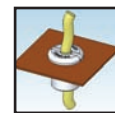

SB



PGSC



Competitor Cross Reference

Richco Part #	Heyco Part #	Micro Plastics Part #	Richco Part #	Heyco Part #	Micro Plastics Part #
PGSB-1	2000	22MP02502	PGSB-1WH	2001	22MP02502W
PGSB-2	2010	22MP03123	PGSB-2WH	2011	22MP03123W
PGSB-3	2810	22MP01015	PGSB-3WH	2811	22MP01015W
PGSB-4	2020	22MP03753	PGSB-4WH	2021	22MP03753W
PGSB-5	2030	22MP03754	PGSB-5WH	2031	22MP03754W
PGSB-6	2038	22MP04374	PGSB-6WH	2039	22MP04374W
PGSB-7	2043	22MP04375	PGSB-7WH	2044	22MP04375W
PGSB-8	2042	22MP04376	PGSB-8WH	2037	22MP04376W
PGSB-9	2817	22MP01020	PGSB-9WH	2818	22MP01020W
PGSB-10	2058	22MP05004	PGSB-10WH	2059	22MP05004W
PGSB-11	2049	22MP05005	PGSB-11WH	2050	22MP05005W
PGSB-12	2820	22MP01030	PGSB-12WH	2821	22MP01030W
PGSB-13	2824	22MP01040	PGSB-13WH	2825	22MP01040W
PGSB-14	2060	22MP05625	PGSB-14WH	2061	22MP05625W
PGSB-15	2063	22MP05626	PGSB-15WH	2064	22MP05626W
PGSB-16	2066	22MP05627	PGSB-16WH	2067	22MP05627W
PGSB-17	2075	22MP06254	PGSB-17WH	2078	22MP06254W
PGSB-18	2070	22MP06257	PGSB-18WH	2071	22MP06257W
PGSB-19	2827	22MP01050	PGSB-19WH	2828	22MP01050W
PGSB-20	2083	22MP06878	PGSB-20WH	2084	22MP06878W
PGSB-21	2086	22MP06879	PGSB-21WH	2087	22MP06879W
PGSB-22	2092	22MP07508	PGSB-22WH	2099	22MP07508W
PGSB-23	2093	22MP07509	PGSB-23WH	2094	22MP07509W
PGSB-24	2836	22MP01060	PGSB-24WH	2837	22MP01060W
PGSB-25	2844	22MP01070	PGSB-25WH	2845	22MP01070W
PGSB-26	2116	22MP08708	PGSB-26WH	2117	22MP08708W
PGSB-27	2120	22MP08709	PGSB-27WH	2121	22MP08709W
PGSB-28	2123	22MP08710	PGSB-28WH	2124	22MP08710W
PGSB-29	2126	22MP08711	PGSB-29WH	2127	22MP08711W
PGSB-30	2850	22MP01080	PGSB-30WH	2851	22MP01080W
PGSB-31	2140	22MP10012	PGSB-31WH	2141	22MP10012W
PGSB-32	2160	22MP10913	PGSB-32WH	2161	22MP10913W
PGSB-33	2163	22MP10914	PGSB-33WH	2164	22MP10914W
PGSB-34	2166	22MP10915	PGSB-34WH	2167	22MP10915W
PGSB-35	2198	22MP12515	PGSB-35WH	2199	22MP12515W
PGSB-36	2210	22MP13716	PGSB-36WH	2211	22MP13716W
PGSB-37	2233	22MP15017	PGSB-37WH	2234	22MP15017W
PGSB-38	2236	22MP15018	PGSB-38WH	2237	22MP15018W
PGSB-39	2240	22MP15021	PGSB-39WH	2241	22MP15021W
PGSB-40	2300	22MP17522	PGSB-40WH	2301	22MP17522W
PGSB-41	2400	22MP20026	PGSB-41WH	2401	22MP20026W



For free samples, literature or technical assistance,
contact our US Headquarters at 800-621-1892

www.richco-inc.com